

QSC KS212C Cardioid Subwoofer

Application Guide



THE KS212C CARDIOID SUBWOOFER. IT'S A KEEPER.

The greatest challenge in pattern control of a loudspeaker system has been the low end, in the subwoofer. That's because the length of the sound waves is inversely proportional to frequency, and the directivity of any source is related to the ratio of its size to the wavelengths it produces. Thus, with conventional subwoofers and loudspeakers, below about 200 Hz the wavelengths become several times greater than the dimensions of the transducer and enclosure and the radiation pattern becomes omnidirectional—constant in all directions, including to the sides and back.

The usual result is that a lot of acoustical energy goes in unwanted directions instead of toward the audience. Rear-radiated energy is almost always wasteful and unusable, and it can disturb neighbors, cause feedback in live performances, and cause vibrations that compromise playback of vinyl records.

While there have been techniques for overcoming the natural omnidirectional behavior of a subwoofer, it has historically been a complicated affair involving multiple subwoofer enclosures spaced and placed in a particular array pattern, multiple amplifier channels, and signal processing to provide the necessary calculated delay and amplitude relationships that will cause cancellation to the back and reinforcement to the front, forming a cardioid dispersion pattern.

WE DID THE MATH SO YOU DON'T HAVE TO.

The QSC KS212C cardioid subwoofer system makes the complex into something simple by combining precise digital signal processing (DSP), 3600 total watts of amplification, and two 12-inch drivers into a single sixth-order bandpass enclosure with apertures in the front and back. As an integrated system, it maintains a good cardioid (heart-shaped) pattern at all frequencies over its entire operational range because the DSP constantly applies the optimal combination of time delay and apportionment of energy to the front and back drivers. The directional pattern has a broad front lobe that distributes the low frequency energy over a wide angle while maintaining a pronounced cancellation null in the back. The result is a front-to-back ratio of 15 dB—that's essentially 32x more power to the front than to the back.

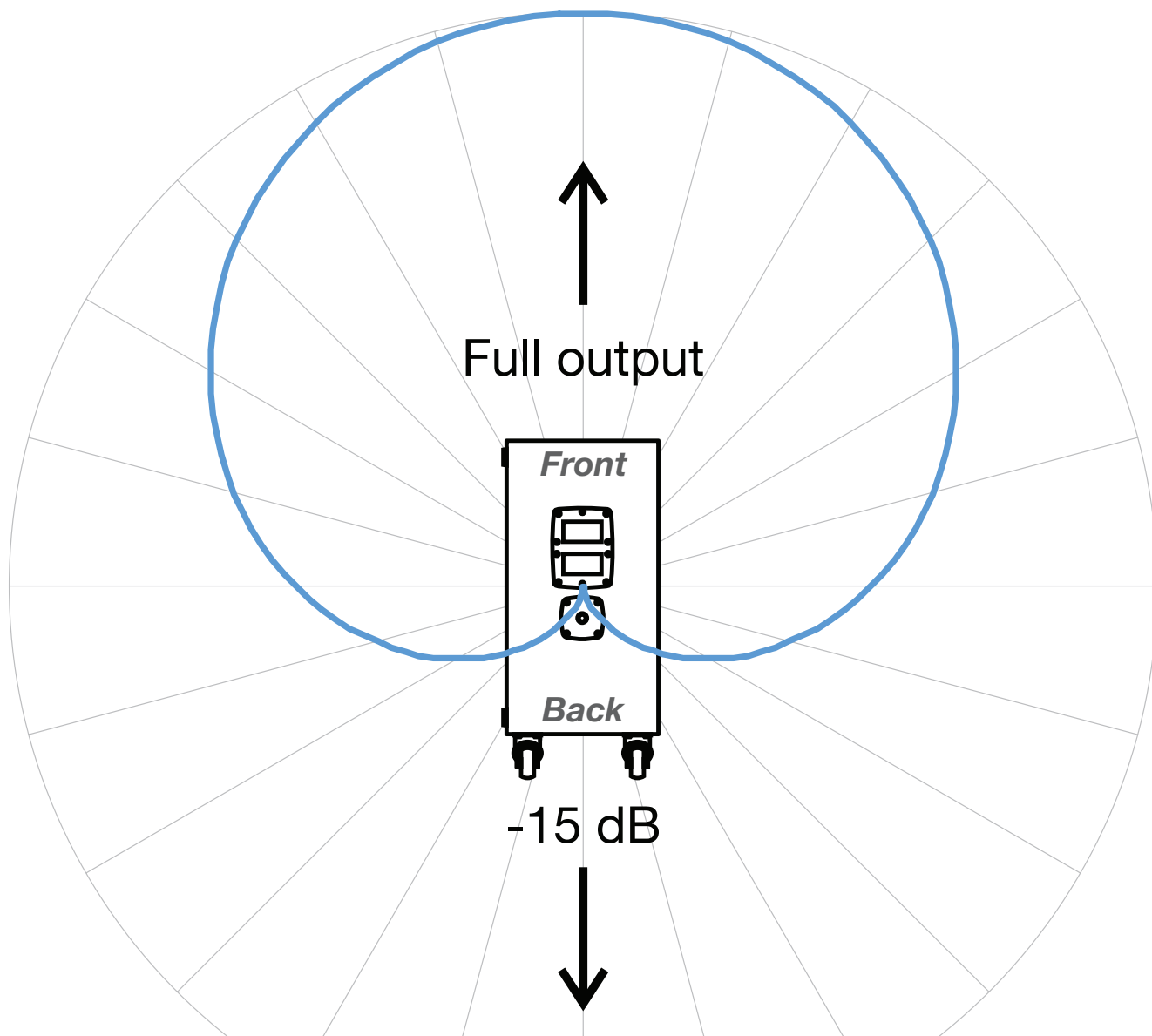

The KS212C features DSP with these user adjustable parameters:

- Crossover frequency—80 Hz for the K.2 Series loudspeakers or 100 Hz for KW, KLA, and legacy K Series.
- Delay—0 to 100 milliseconds, indicated in milliseconds, feet, or meters; this is used for time aligning the subwoofers with the tops.
- Scenes—stores as many as five recallable user scenes that contain all DSP settings.

KEEP THE NEIGHBORS HAPPY

Everyone loves a great concert or party or other event except perhaps for the people nearby who aren't attending. The most objectionable sounds—the deep bass—are right in the subwoofer range and they tend to penetrate through walls and cover longer distances outdoors. These are the noises that most often lead to noise complaints, police visits, and other ill will with neighbors. But with the KS212C cardioid subwoofer instead of a conventional omnidirectional subwoofer you can aim its null right where you don't want to blast the bass. You can aim the rumble away from a wall or a residential area to keep peace with the neighbors and still have great low-end coverage where you want it.

Outdoor event

Here's an example of an outdoor event with a small rock band and DJ. This could be a wedding reception, a company picnic, etc., at a country club, at a park, or even in a backyard. And ... there are homes nearby.

By using KS212C cardioid subwoofers, the usual low-frequency thump that travels long distances can be kept away from where it would disturb the neighbors, and yet the people at the event can still enjoy the party.

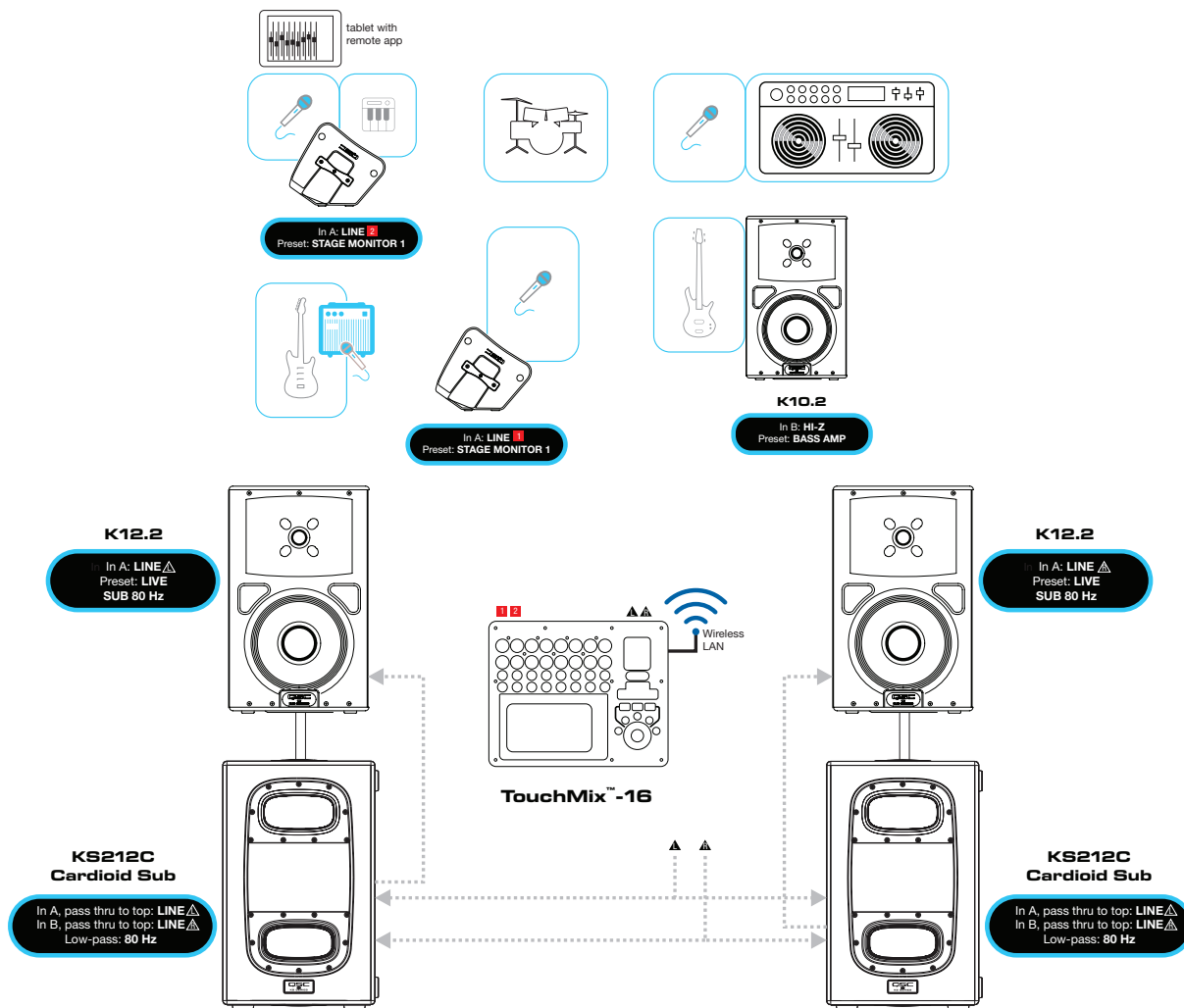

Outdoor festival

The KS212C is a perfect complement to the KLA12 line array loudspeakers, too. So for events like outdoor festivals you can match the superior pattern control of a line array to the superior pattern control of a cardioid subwoofer system and keep peace with the neighbors!

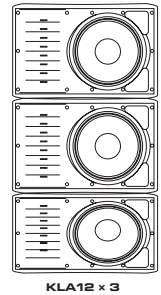
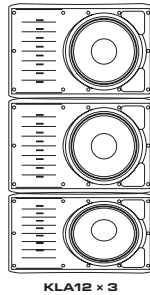

Stage

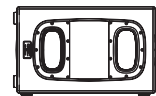
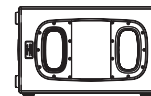
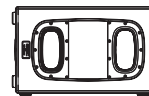
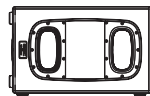

KS212C x 4 in front of stage

KEEP FEEDBACK DOWN

Performing musicians know there's nothing more fun than giving the audience a visceral experience, and subwoofers can be a significant part of that. But uncontrolled bass that you can feel out front in the seats can also couple into a stage and vibrate the mics and stands, drum snares, tube instrument amps, etc. This rumble can cause distortion and even feedback when it goes back into the sound reinforcement system. Cardioid subwoofer systems are useful at controlling these low-frequency sounds, keeping energy where it's wanted and away from where it is harmful.

This works especially well for stages where the subwoofer is either right in front or to the front and toward the sides. In this example the subwoofer sits in front of the stage. A conventional one would flood the stage with low-frequency sound that could get into the stage mics and would probably be irritating and fatiguing to the band. The KS212C will deliver those low frequencies to the audience and not the band. Because the subwoofer is forward of the plane of the main loudspeakers, the operator dials in a few milliseconds of delay in the subwoofer to align it with the mains.

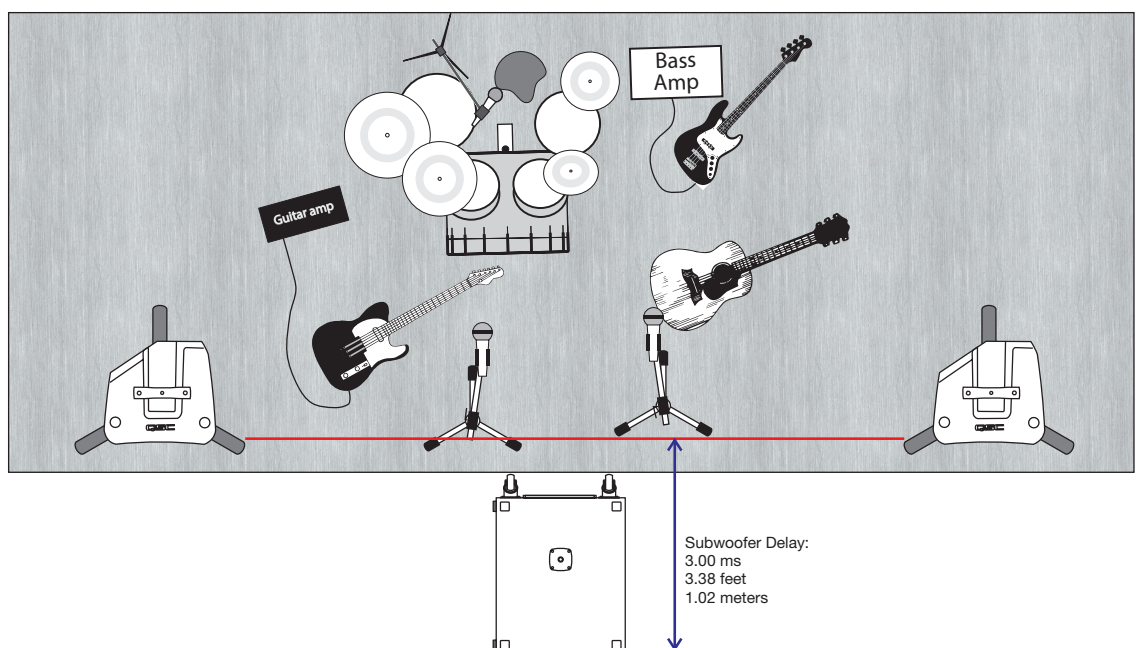

KEEP THE NEEDLE IN THE GROOVE

DJs who spin vinyl know that subwoofers are great for getting people dancing and having a great time but they can also rock the turntables on the rig. When these vibrations couple into the platter and the disc, they also bounce the stylus and cartridge. In extreme cases they'll bounce the stylus right out of the groove!

Here's where the KS212C again comes to the rescue. The DJ can operate his or her rig in the null of the subwoofer and not have the turntables jostled by the dance-inducing beats. With multiple subwoofers, their nulls can be aimed as shown in the picture to have the least effect on the turntable and stylus. The pole-mounted K.2 loudspeakers on top provide crisp, clean sound.

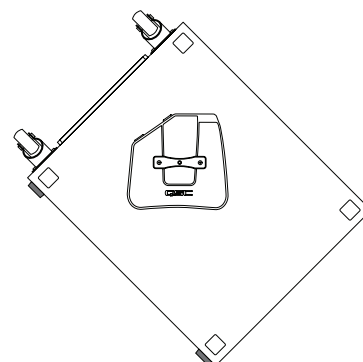
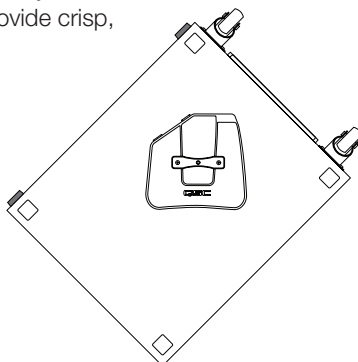
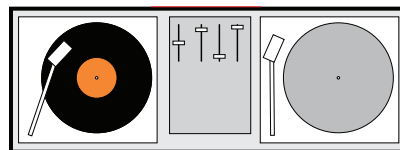

KEEP THE DRUMMER IN THE GROOVE

A subwoofer in the drummer's monitor system will help him or her keep the groove. A KS212C cardioid subwoofer will help the other band members remain sane.

The versatile QSC K.2 Series loudspeakers are ideal tops for a monitor system, and they pair perfectly with the KS212C.

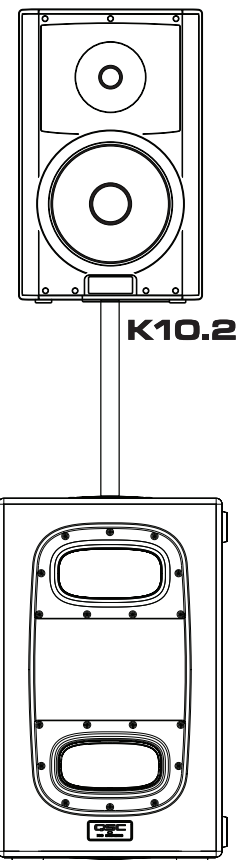

CARDIOID SUBWOOFER PLACEMENT (NOT THE SAME AS CONVENTIONAL SUBWOOFERS!)

Walls and surfaces

You probably know the trick of putting a subwoofer against a wall or in a corner to concentrate that omnidirectional acoustical energy into one-quarter space (where a wall and the floor meet) or one-eighth space (a corner where two walls meet the floor). This works for conventional subwoofers but is detrimental to cardioid subwoofer operation. The KS212C cardioid subwoofer needs space around its top and sides for a free acoustical path between the front and rear ports. This is so the sound from the front and rear can interact properly and produce the directional dispersion pattern.

Keep the KS212C away from walls or other obstructions in any direction by at least 20 inches or 50 cm. It is always best to not place cardioid subwoofers under a stage, but if it is unavoidable the underside of the stage should be at least that distance away from the subwoofer enclosure.

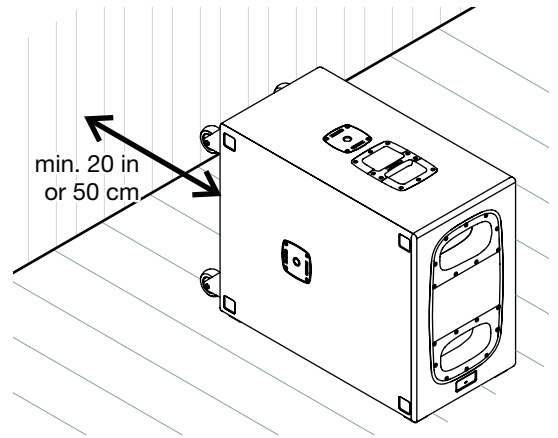

Deploying multiple cardioid subwoofers

A popular and effective way to deploy conventional subwoofers is to pack them together tightly. This way, they act as one large unit.

This is not ideal for cardioid subwoofer operation, though. If you pack the KS212C enclosures together, you will change the length of some of the acoustical paths between the front and rear ports, which will degrade the quality of the rear cancellation. As a result, the directional response will be less cardioid.

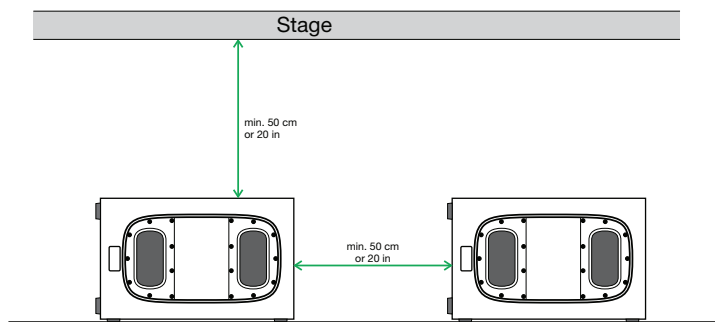

As with walls, stages, and other obstructions, keep at least 20 inches or 50 cm between the KS212C enclosures, whether they are set vertically or horizontally.

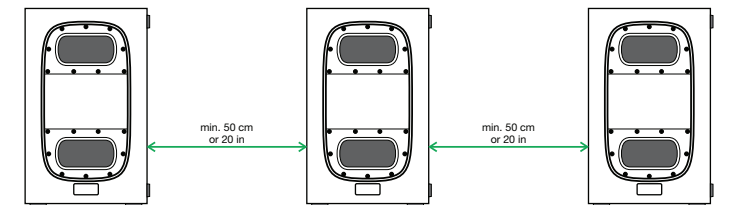

Stacking subwoofers (if you have to)

In some situations you might have to stack subwoofers, one on top of the other. While this is not ideal, you can still get decent cardioid performance with two KS212C subwoofers laid horizontally and stacked vertically. The front-to-rear ratio drops to 12.5 dB, but that may be an acceptable trade-off. Stacking more than two subwoofers is unadvisable, and do not stack KS212C subwoofers that are oriented vertically.

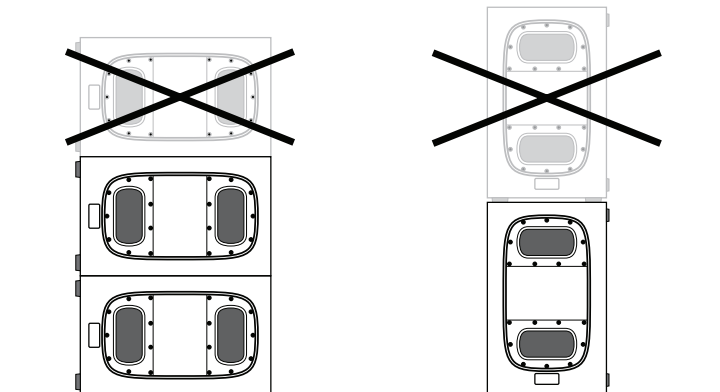



(800) 854-4079 or (714) 957-7100
Outside the U.S. +1 (714) 754-6175
Fax: +1 (714) 754-6174

QSC, LLC
1675 MacArthur Boulevard
Costa Mesa, CA 92626 USA